



Norwich Western Link

Environmental Statement

Chapter 10: Biodiversity

Appendix 37: Solar Exposure Analysis

Sub Appendix A: Sunlight Hours Assessment

Author: WSP

Document Reference: NCC/3.10.37a

Version Number: 01

Date: December 2023



Contents

1	Introduction	3
---	--------------------	---



1 Introduction

- 1.1.1 This document presents a series of figures showing the outputs of the Sunlight Hours modelling analysis for the permanent viaduct structure and associated temporary works. The figures show the modelled Seasonal and Annual sunlight hours for multiple scenarios including: Baseline Scenario; Temporary Works Scenario; Temporary Works to Baseline Ratio; Temporary Works and Permanent Structure Scenario; Temporary Works and Permanent Structure to Baseline ratio; Permanent Structure Scenario; and Permanent Structure to Baseline Ratio.
- 1.1.2 We have included a summary of key information shown in this document in an accessible format in section 1.1.1. However, some users may not be able to access all technical details that are included in the rest of this document. If you require this document in a more accessible format, please contact norwichwesternlink@norfolk.gov.uk

Appendix A

Sunlight Hours Assessment

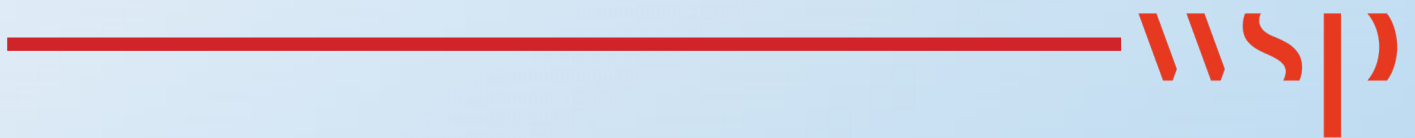

A.1 Seasonal Results

Baseline Scenario

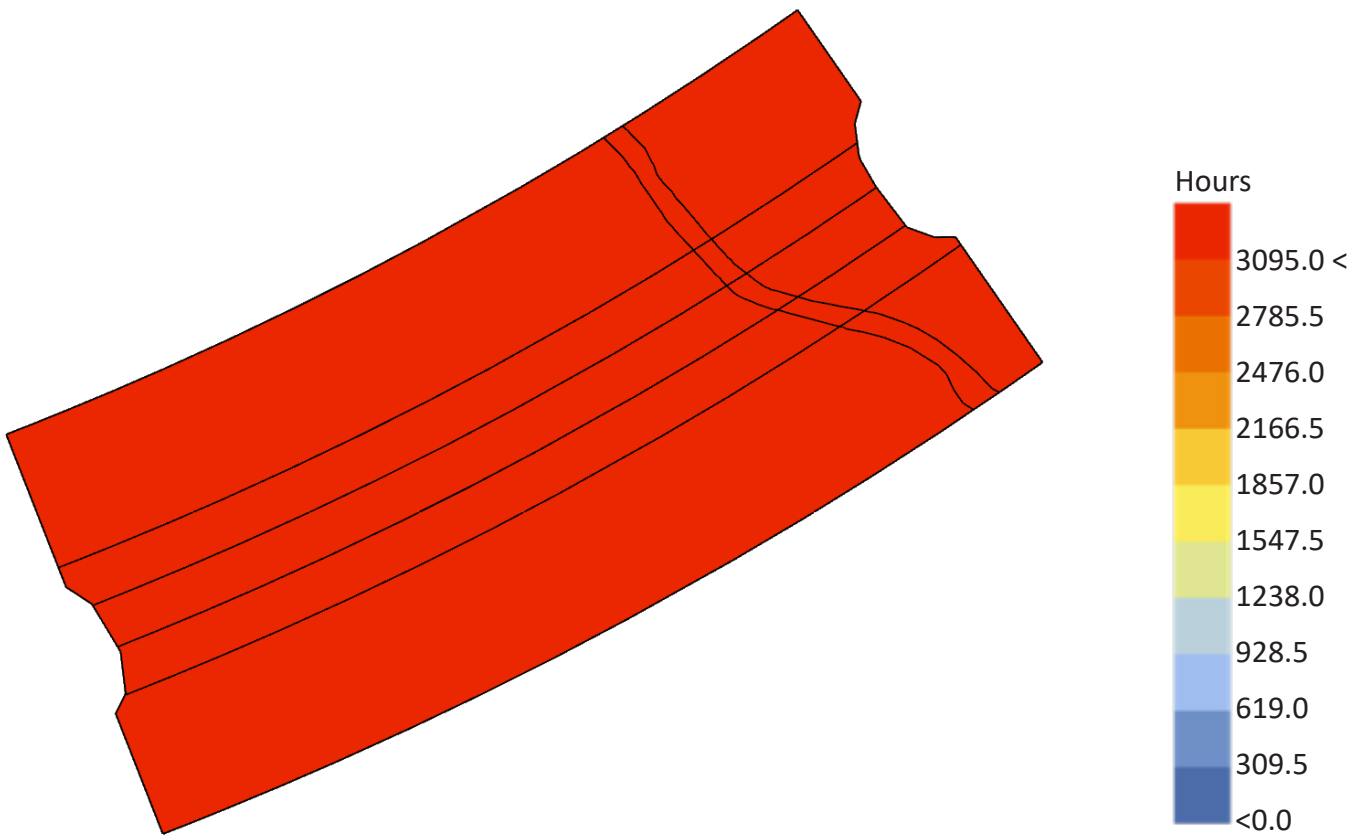

Temporary Works Scenario

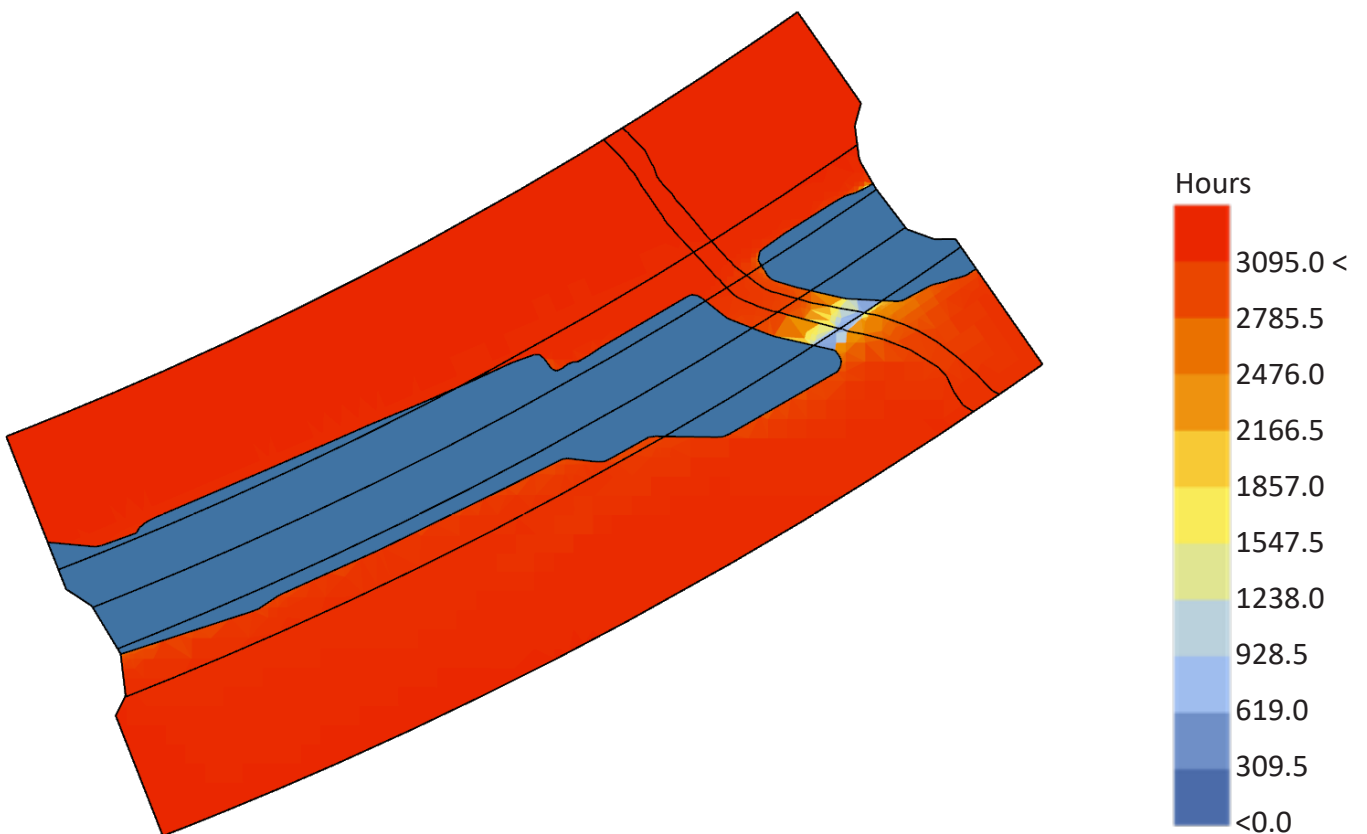

Temporary Works to Baseline Ratio

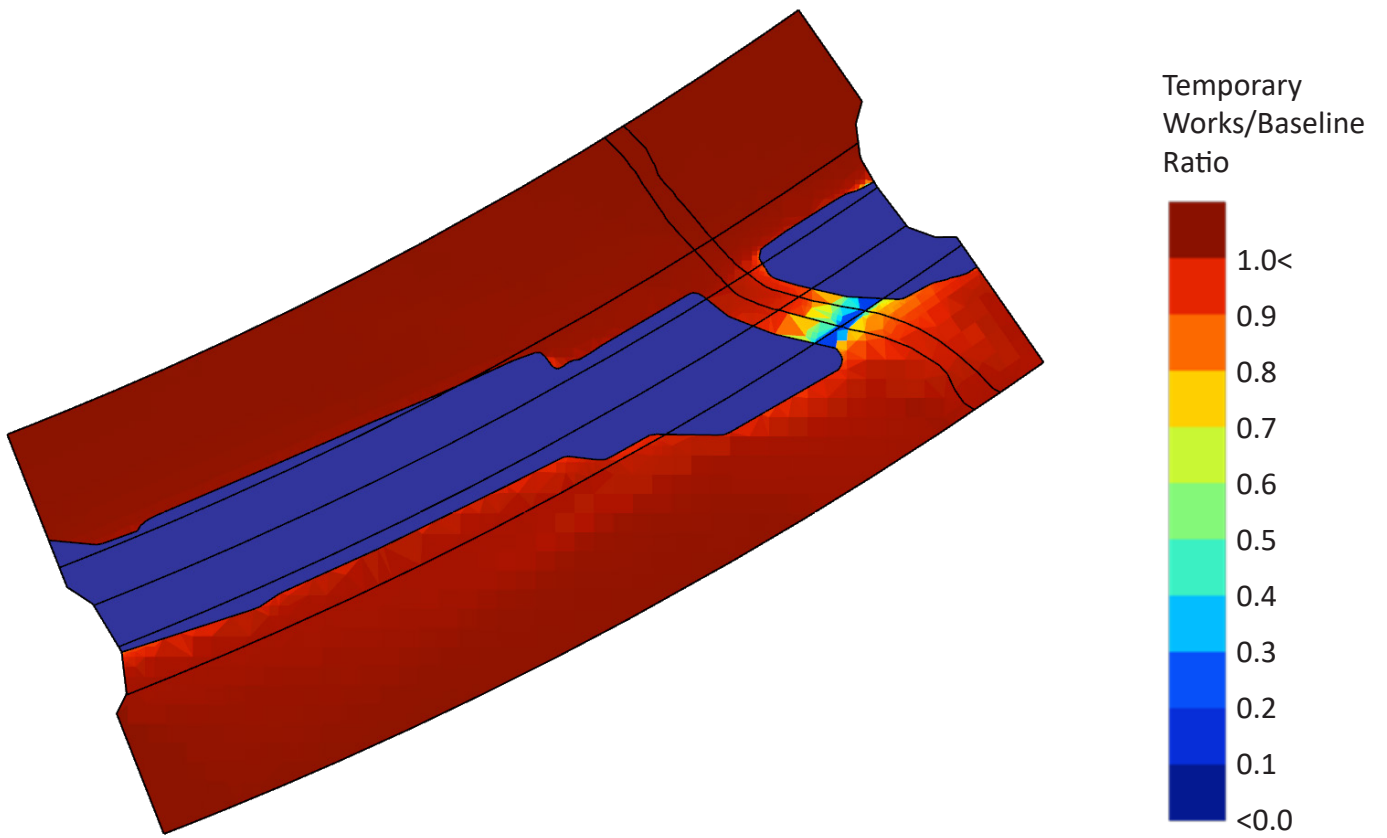

Temporary Works & Permanent Structure Scenario

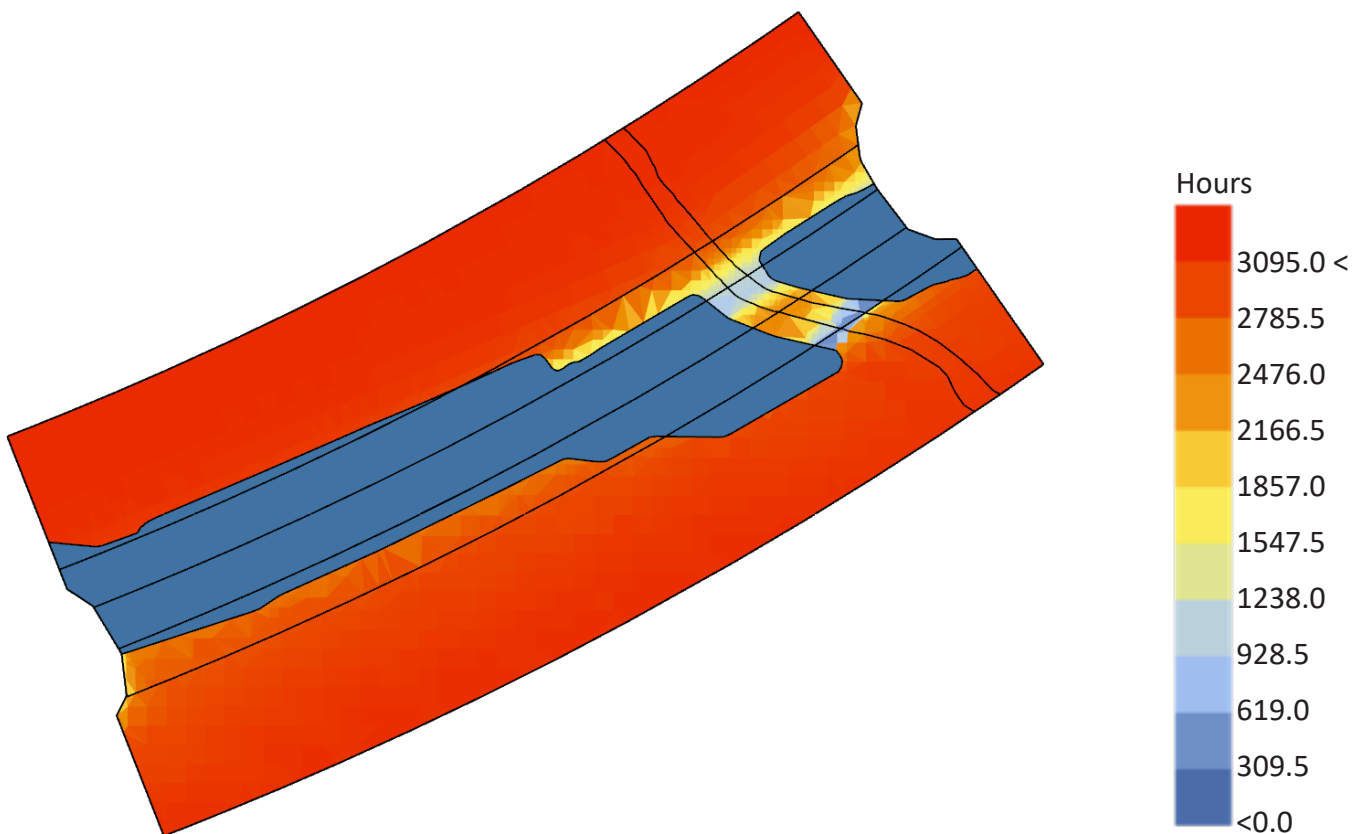

Temporary Works & Permanent Structure to Baseline Ratio

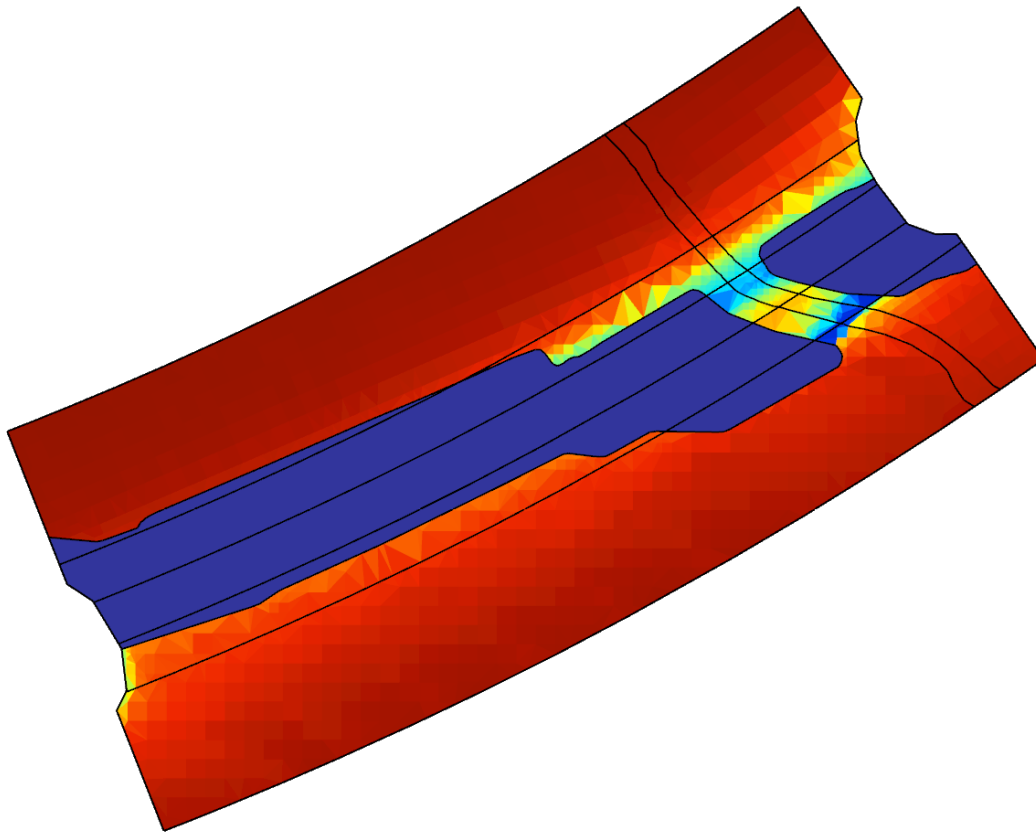

Temporary Works & Permanent Structure/
Baseline Ratio

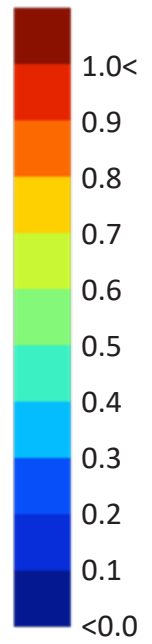

Permanent Structure

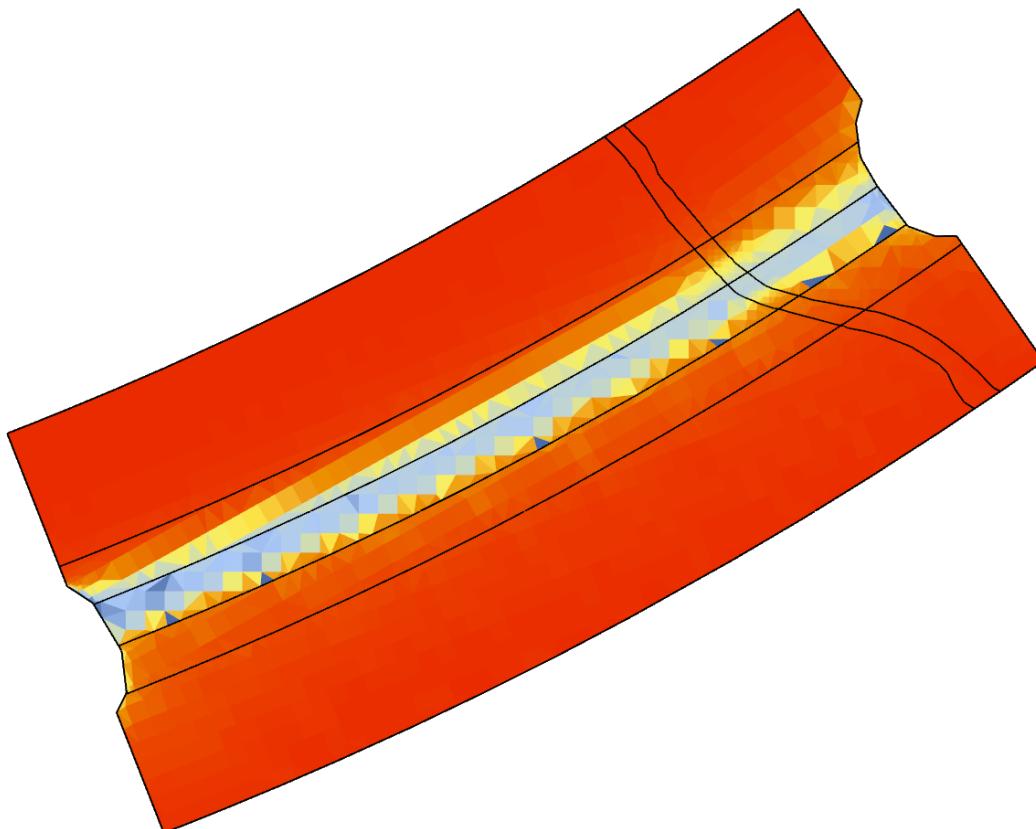

Hours

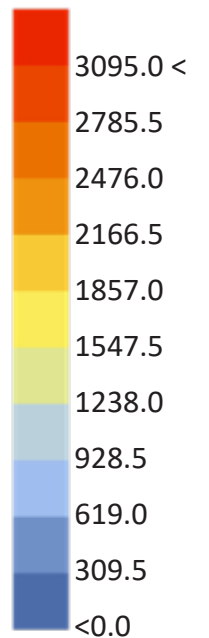

Permanent Structure to Baseline Ratio

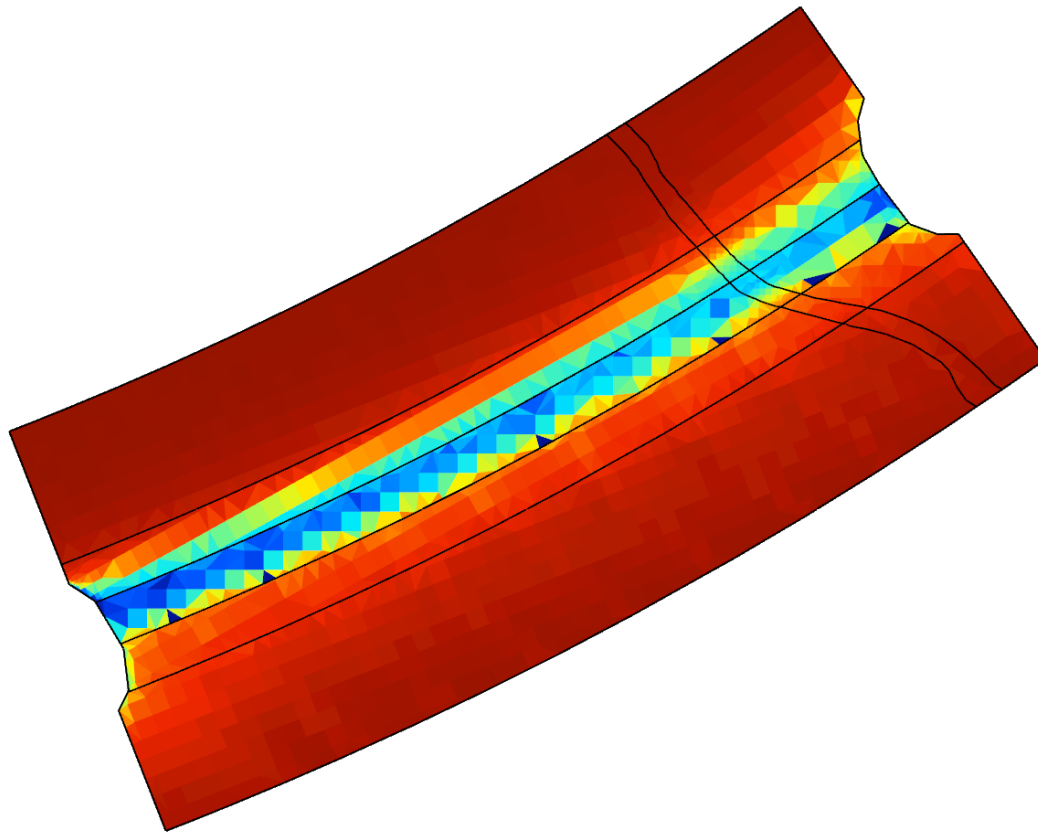

Permanent Structure/Baseline Ratio



A.2 Annual Results

Baseline Scenario

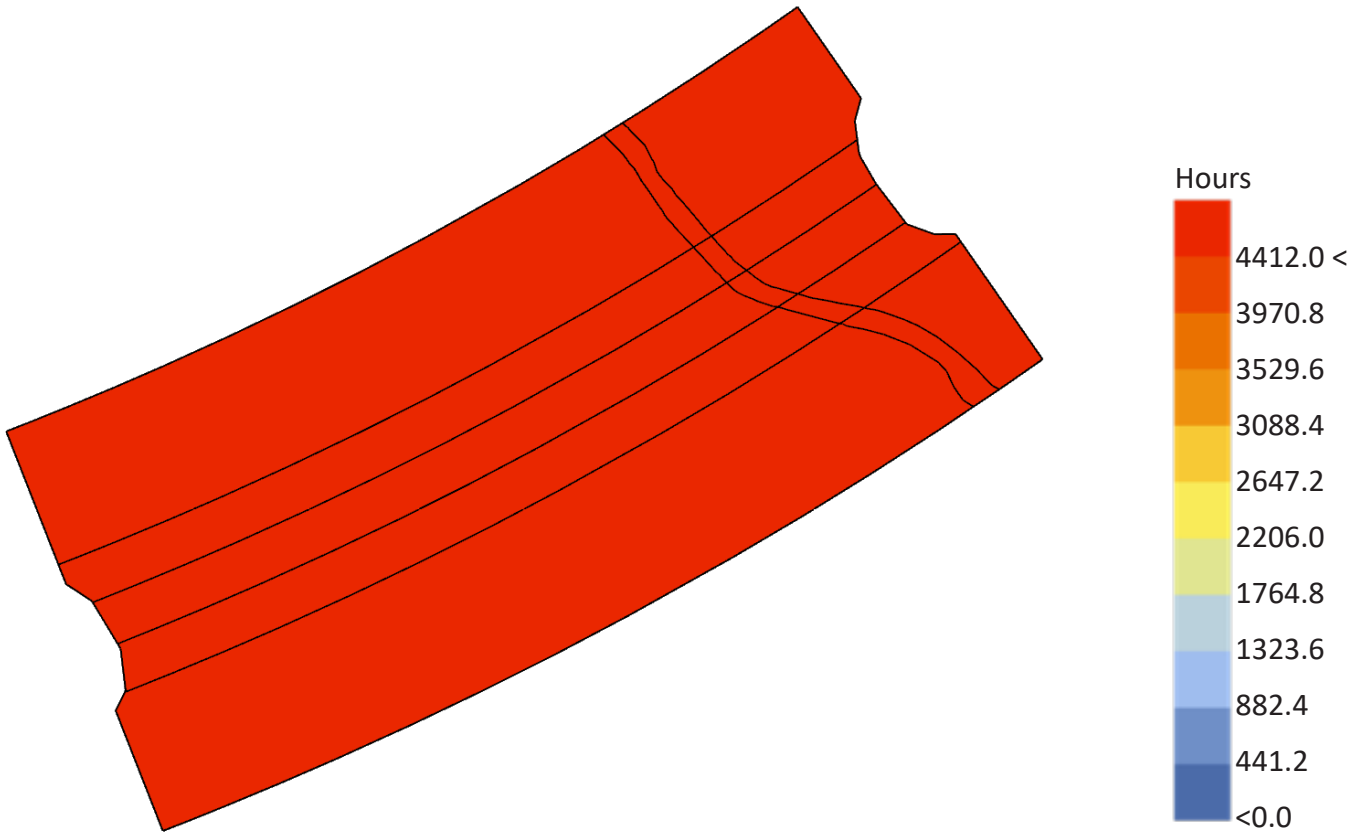

Temporary Works Scenario

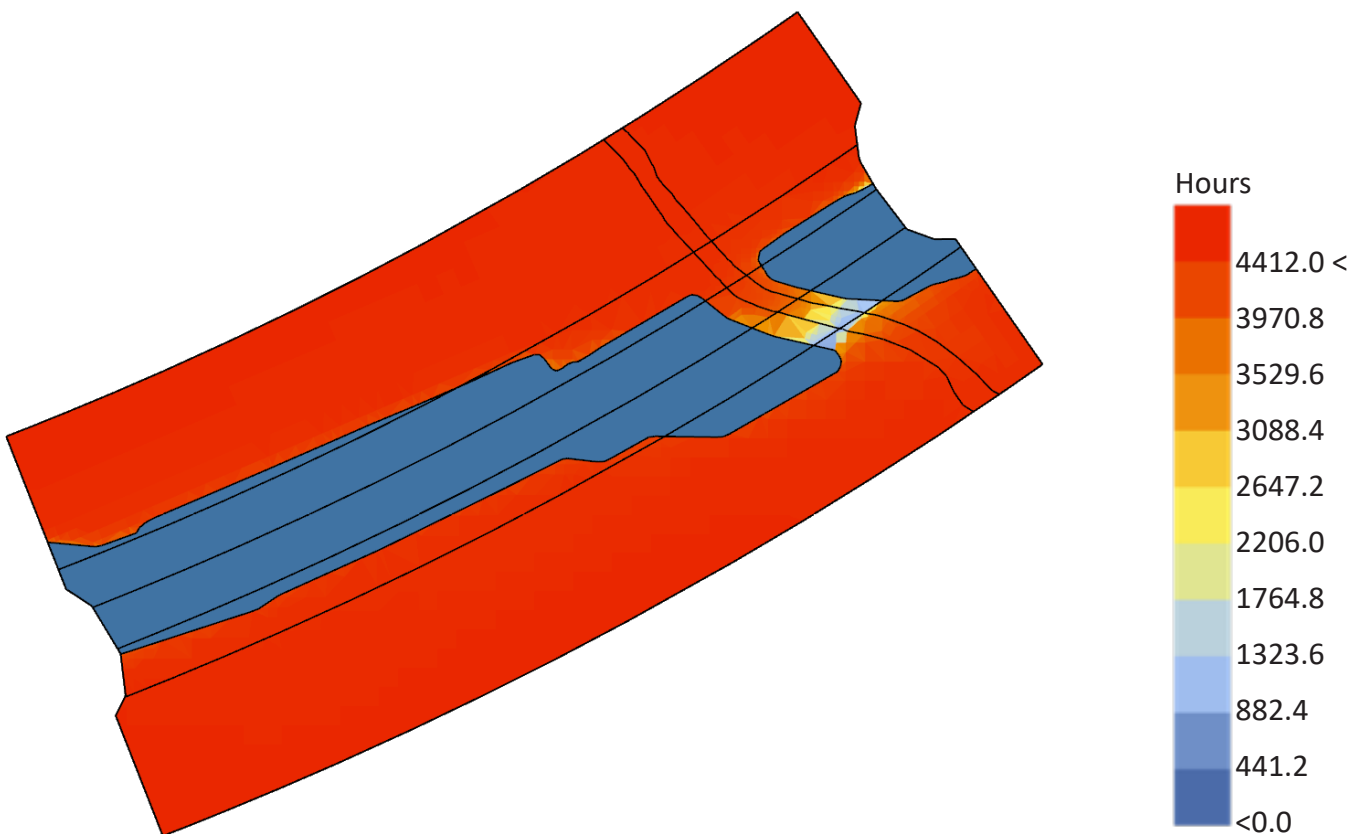

Temporary Works to Baseline Ratio

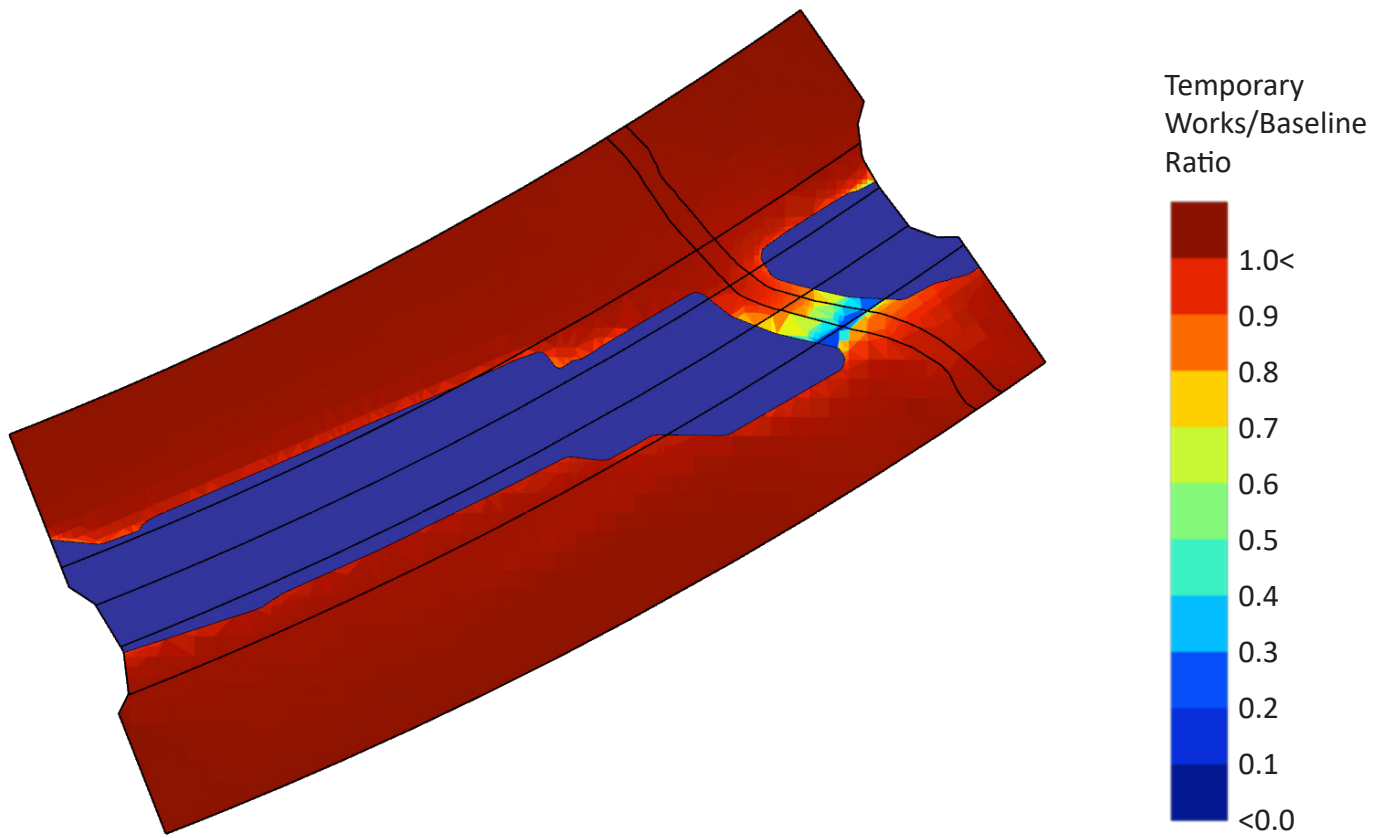

Temporary Works & Permanent Structure Scenario

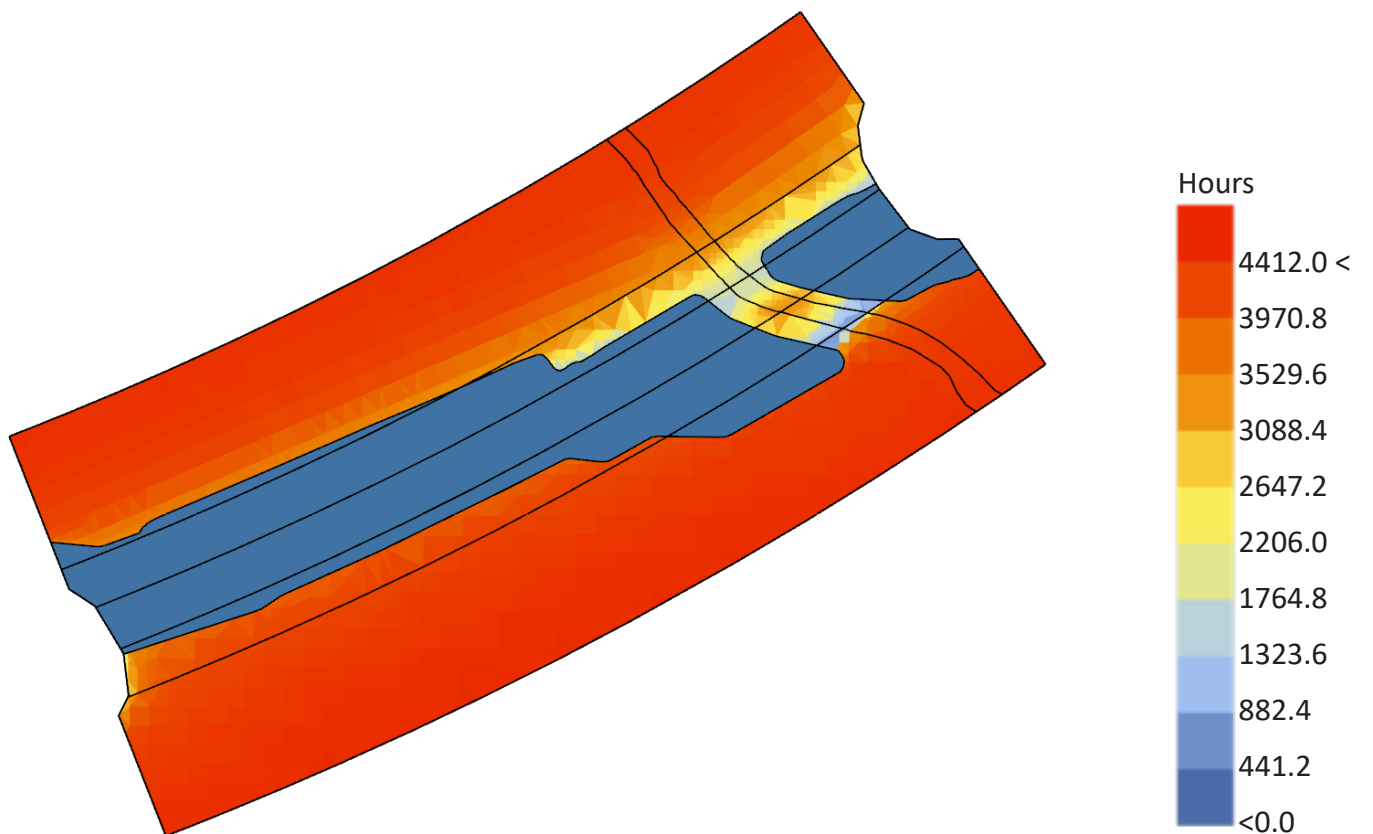

Temporary Works & Permanent Structure to Baseline Ratio

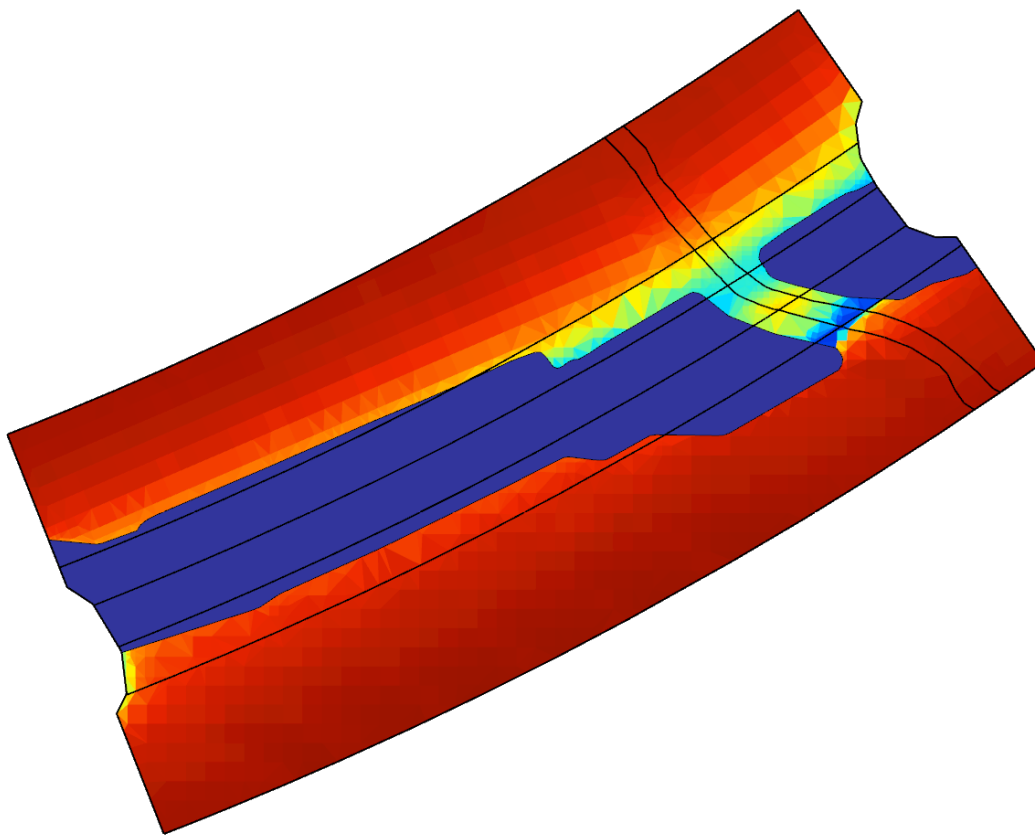

Temporary Works & Permanent Structure/
Baseline Ratio

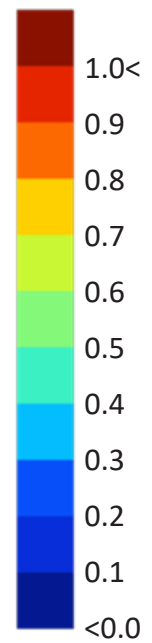

Permanent Structure

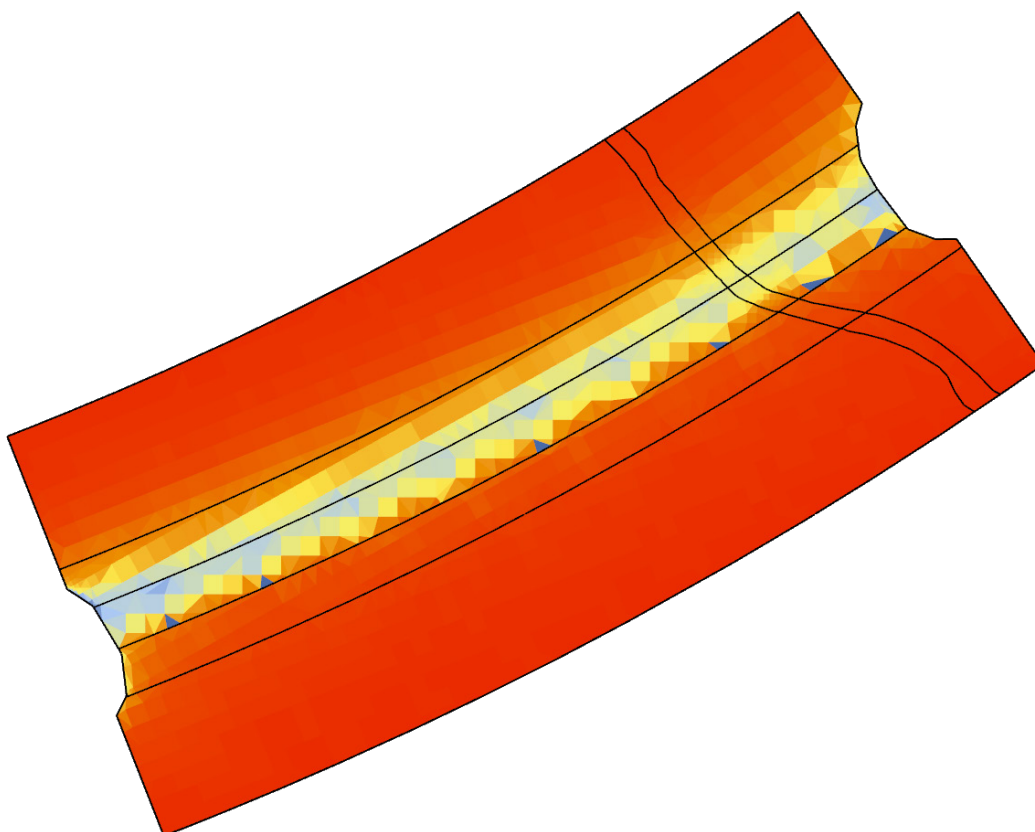

Hours

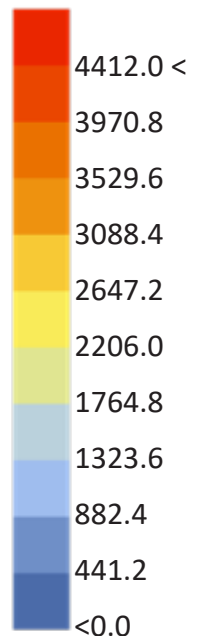

Permanent Structure to Baseline Ratio

